

NOTES: UNLESS OTHERWISE SPECIFIED

REVISION HISTORY			
REV	DESCRIPTION	APPROVED	DATE

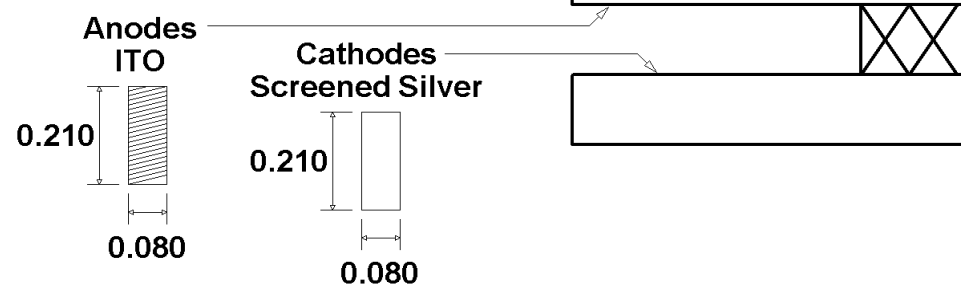

APPROVALS		DATE	TITLE	
DRAWN	J TAYLOR	03/31/12	BR12261 Panaplex 11 x 7 segment gas discharge display mech outline	
CHECKED				
ENGINEER				
PROJ ENGINEER			SIZE	FSCM NO.
APPROVED			B	
QA			DRAWING NO.	0161.DSN
SCALE		NONE	REV.	-

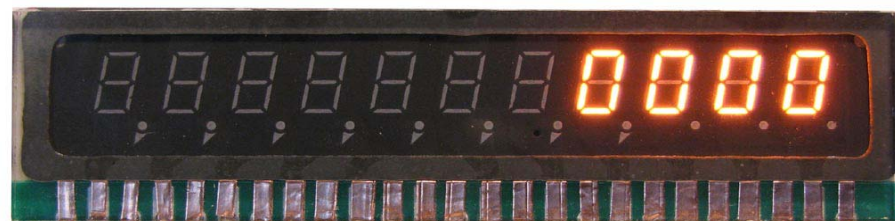
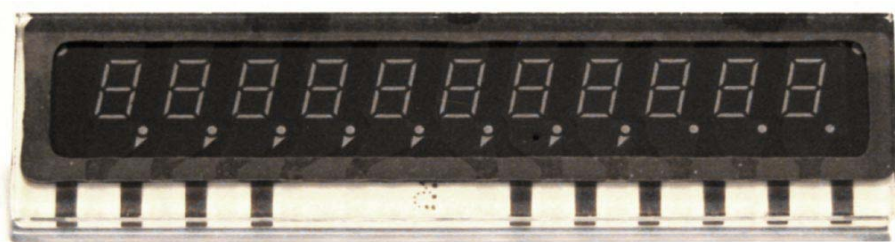
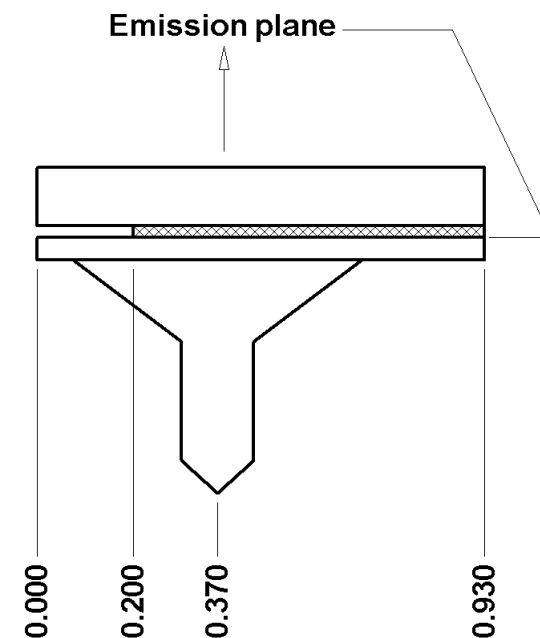
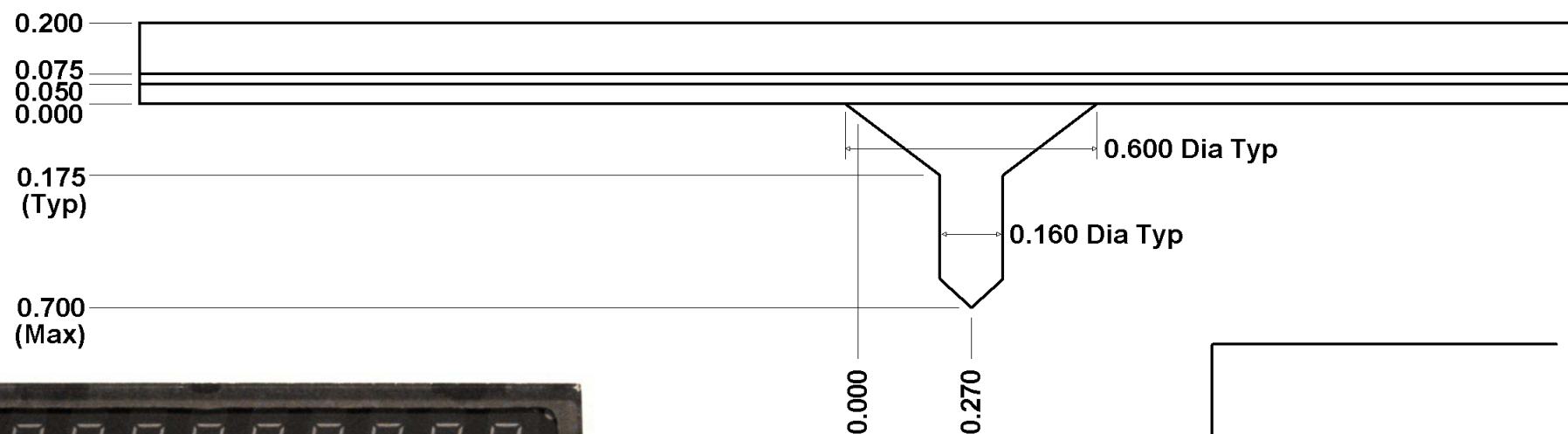
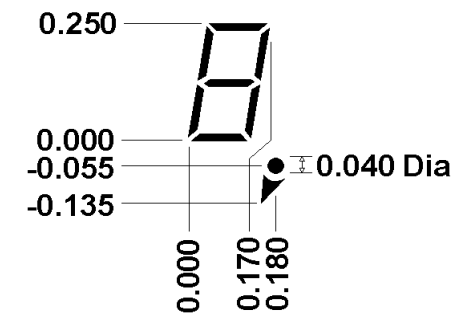
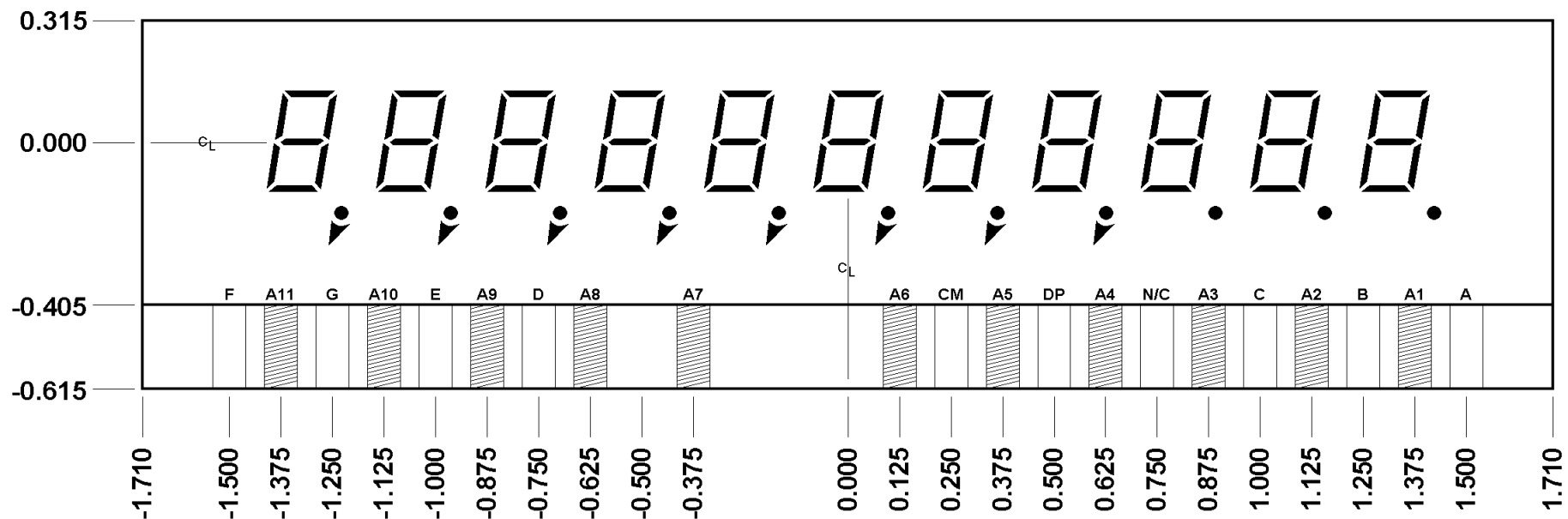

MODIFIED: 03/31/12 2:00:24 PM

SHEET 1 OF 1